

# TEKSCOPE



Colin Barton



Customer Information from Tektronix, Inc.,  
Beaverton, Oregon 97077

Editor: Gordon Allison  
Ass't. Editor: John Mulvey

## Contents

### 2 A desktop graphic computing system

The TEKTRONIX BASIC Graphic Computing System combines high-level BASIC language interaction, built-in computing, and local tape memory—plus the unique graphing capabilities of the Tektronix display.

### 8 Graphing with the 4051 Graphic Computing System

Graphing with the 4051 makes sense. You graph using your own data units, with the Interpreter converting your data units to Graphic Display Units for plotting on the 4051 crt or a peripheral device.

### 11 A high-stability 100 kHz to 1.8 GHz tracking generator

A companion to the 7L13 Spectrum Analyzer, the TR 502 Tracking Generator provides a highly-stable, leveled signal for characterizing devices and systems up to the full 1.8 GHz bandwidth of the 7L13.

### 15 Delayed gate aids oscilloscope digital measurement

Using the delayed gate to control digital plug-ins in a 7000 Series Oscilloscope, opens the door to some unique measurement capability.

### 17 Repairing probe tips, bodies, and boots

Some hints for keeping your probes in good operating condition at minimal cost.

### 19 New products

A brief summary of what's new from Tektronix.

## A desk-top graphic computing system

With the cost of memories and processors on the decline, the economies of scale of big computers are slowly diminishing. Communications costs are high. There are often long waits for results, and the system can take as much as 40% of its time trying to figure out what to do next. Like big cities, big computers are fraught with problems. In the future, more and more computing will be done locally at the desk of engineers, business analysts, scientists, etc.

As society progresses technologically the problems faced in all fields increase in complexity. People need to devote all their energy to whatever is facing them. Having to understand the problems of putting together a computer system should not be one of their tasks. So the 4051 is not a collection of hardware and paper tape for a user to get along with somehow. Instead, it is designed so all of its facilities are easy to use. It avoids user perceived complexity. A desktop system should be an extension of a user's mind. The 4051 does this in four ways:

1. It is a machine using a people-oriented higher-level language . . . extended BASIC.
2. It uses graphics to help a user perceive a problem more naturally, see a solution in perspective.
3. The acquisition of data by and from instrumentation can be handled using the same language . . . extended BASIC.
4. The 4051 can efficiently access host computer files.

### The language

For those who already know BASIC as a programming language little needs to be said about its simplicity and conversational character. A lot of very careful, capable thinking went into the development of the language to make it simple to learn as well as suitable for a wide range of disciplines. Today it is widely used. Only a few hours with a self-study book gives you a feel for the language. A few days of study will make you an apprentice programmer.

The main thing experienced programmers question is whether BASIC is adequate to solve their toughest programs. When you already know a more complicated language and have access to machines that use it, there may be little opportunity or reason to learn about the limits of BASIC. That

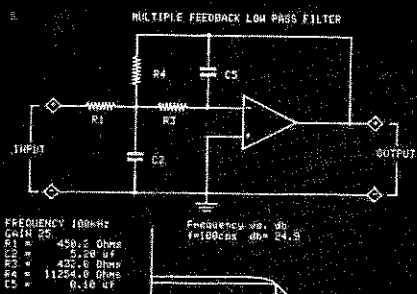

FREQUENCY 100kHz  
 GAIN 25  
 R1 = 450.0 Ohms  
 R2 = 5.00 uF  
 R3 = 420.0 Ohms  
 R4 = 11204.0 Ohms  
 C1 = 0.10 uF

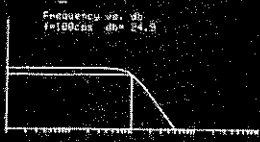

4851 GRAPHIC SYSTEM

POWER

RESET



factor will probably retard wide-spread understanding of its great power. However, counterbalancing that factor will be people who recognize the comparatively small investment necessary to develop the expertise with BASIC to know, instead of guess at, its limitations. For people who already know a language like FORTRAN, learning BASIC is a snap. There is even a tutorial tape cartridge for the 4051 that is like a programmed instruction course. It is good for beginners as well as experienced programmers.

There probably is no "pure" form of BASIC in practical use. Most equipment uses extended forms that differ somewhat from one manufacturer to the next, and even from one kind of equipment to the next from the same manufacturer. But these differences typically don't cause big problems. Many programs already written in BASIC can be used with little or no alteration in the 4051. And alterations are simple to make right from the keyboard, using the edit facilities.

### Language extensions for graphics

The ability of the 4051 to depict information in graphic form, as distinguished from simply displaying alphanumeric characters and a few straight lines, may be its most valuable feature. But many who need computer data in graphic form may not even know it. You need to think about it a little to know. And if you have always expected computer output in the form of letters and numbers, because that is all you have seen you haven't seen enough. When it comes to your pay check, for example, characters you call take-home pay may be clear enough. But how does your take-home pay over the past 120 months compare to the cost of living? You might be shocked but if this were a scientific business statistic, it would be far better to know than to guess. Would you like that information in a column of 120 figures, or would you prefer a graph?

The need to *compare* data is just as real as the need to have data. A computing system that doesn't help you with the comparisons you need to make may be doing only half its job. And graphs provide a versatile means of comparing data in an easy to understand form.

Only eleven keywords are added to BASIC to handle graphics. Here are a few key concepts represented by keywords:

- VIEWPORT:** Controls how much of the output surface is used for a graph and where the boundaries will be.
- WINDOW:** Controls what portion of the available X-Y coordinate data will be placed in the viewport.
- SCALE:** Divides the X-Y coordinates of the viewport into segments corresponding to the proper numeric values for the graph.
- POINTER:** Causes the machine to display an arrow positionable with the optional Joystick.
- DRAW:** Draws a straight line between the present position of the cursor and a specified point in the WINDOW.
- RDRAW:** (Relative draw) Draws a straight line between the present position of the cursor and a point in the WINDOW specified relative to the position of the cursor.
- MOVE:** Like DRAW except no line is produced.
- RMOVE:** Relative move. Like RDRAW except no line is produced.
- AXIS:** X and Y axis lines are drawn and scale tick marks located.
- GIN:** Graphic Input. Records the location of the graphic point: either the point of the arrow or the lower left corner of the normal 5 x 8 dot matrix rectangular cursor.
- ROTATE:** Causes relative draw or relative move to follow a path that departs from the normal by a specified number of radians or degrees.

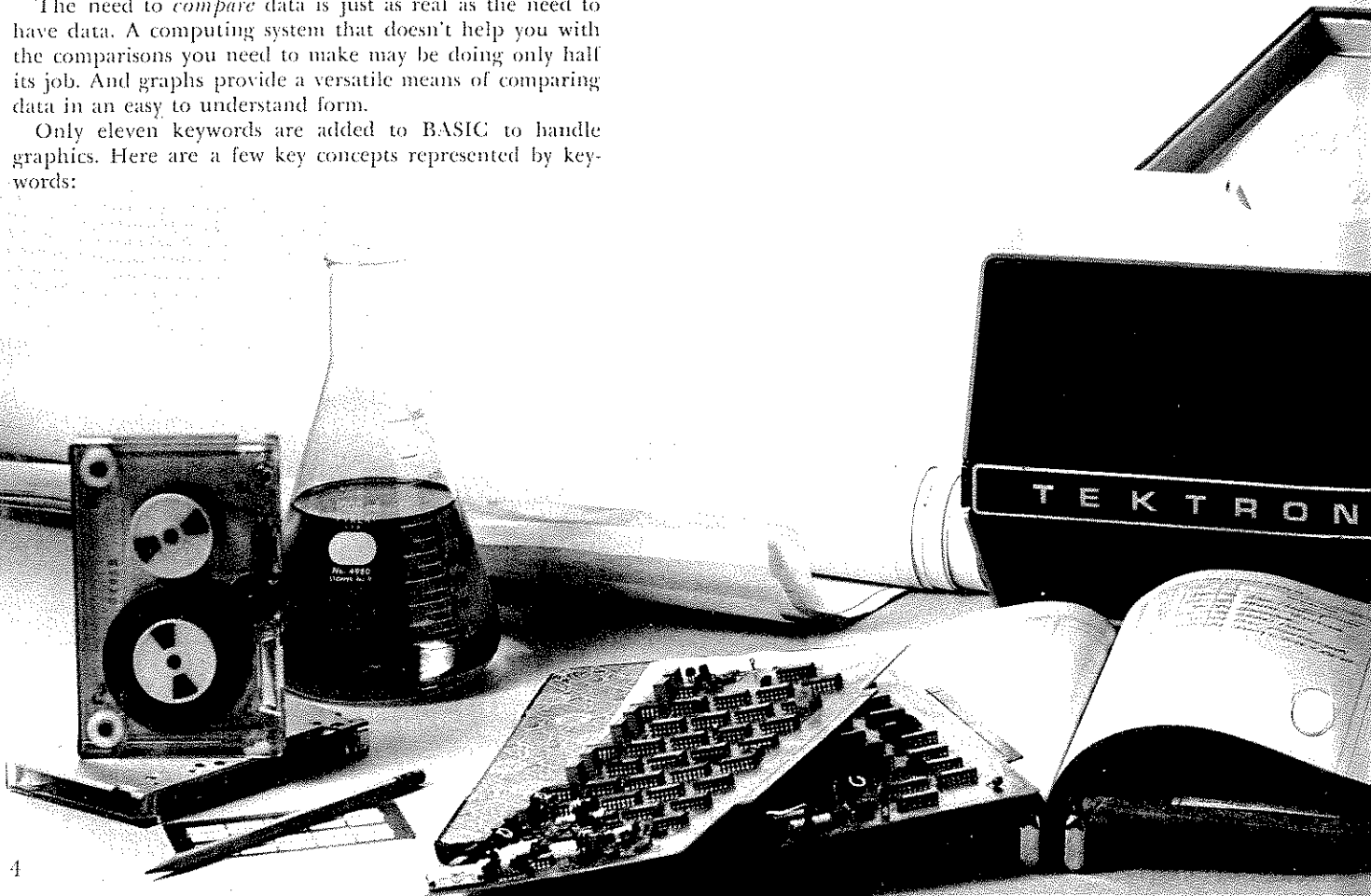

### Listener, talker, controller

The 4051 is designed to control the operation of instruments in the same sort of way as larger computer-based systems. Whether you want to simply monitor and analyze processes, or control processes, the capability is built in. Perhaps top on the list of the advantages the 4051 offers over former test and process controllers is that it has a new standardized, general-purpose, interfacing system (GPIB). This system, now standard in the U.S., is close to being an international standard. Peripheral instruments under control of the 4051 may be classified as Talkers, Listeners, or both. The 4051 may talk, listen, or control, according to its program and signals on the GPIB. The way in which it goes about this is what has been standardized. Commercially available Talkers or Listeners are already compatible. Future designs will be. The 4051 is at the forefront of a new era of instrument test, measurement, and process control. The U.S. Standard is called IEEE Std 488-1975. It was adopted this year. This standard was sponsored by the IEEE Instrumentation and Measurement Group and is based on work initiated by Working Group 3 of Technical Committee 66 of the International Electrotechnical Commission (IEC). The full title is IEEE Standard Digital Interface for Programmable Instrumentation.

The importance of the standard to many customers is hard to overestimate. It means that equipment built to comply with the standard should work together as a system regardless of who made it. It doesn't mean that any combination of compatible pieces constitutes a worthwhile entity, but it does eliminate the costly, confusing need to do custom interface design work to make some pieces of equipment work together that were not originally intended to.

IEEE Std 488-1975 is for digital data interchange between as many as fifteen pieces of equipment that are separated by no more than a total of 20 meters of interconnecting cables. Data is exchanged with the 4051 at any rate up to 7000 bytes per second and is transmitted in 8-bit bytes over the 8-line Data Bus. Each data byte transfer is controlled by a handshake routine over a 3-wire bus. Five other signal lines are devoted to interface management. Figure 1 shows the bus structure that is shared between different devices that can be connected together in a system. Although any of the devices may talk or listen, only one may control the others and itself. The 4051 has that capability. It constitutes an exceptionally universal tool for controlling sophisticated processes by continually acquiring and analyzing data before issuing new program instructions to its listeners. A copy of the Standard may be purchased from: Standard Sales, IEEE, 345 East 47th Street, New York, NY 10017.

### Data communications

The 4051 rear panel has connectors that provide standardized data transfer paths with peripheral equipment in the outside world in *two* standard ways. One is via IEEE Std

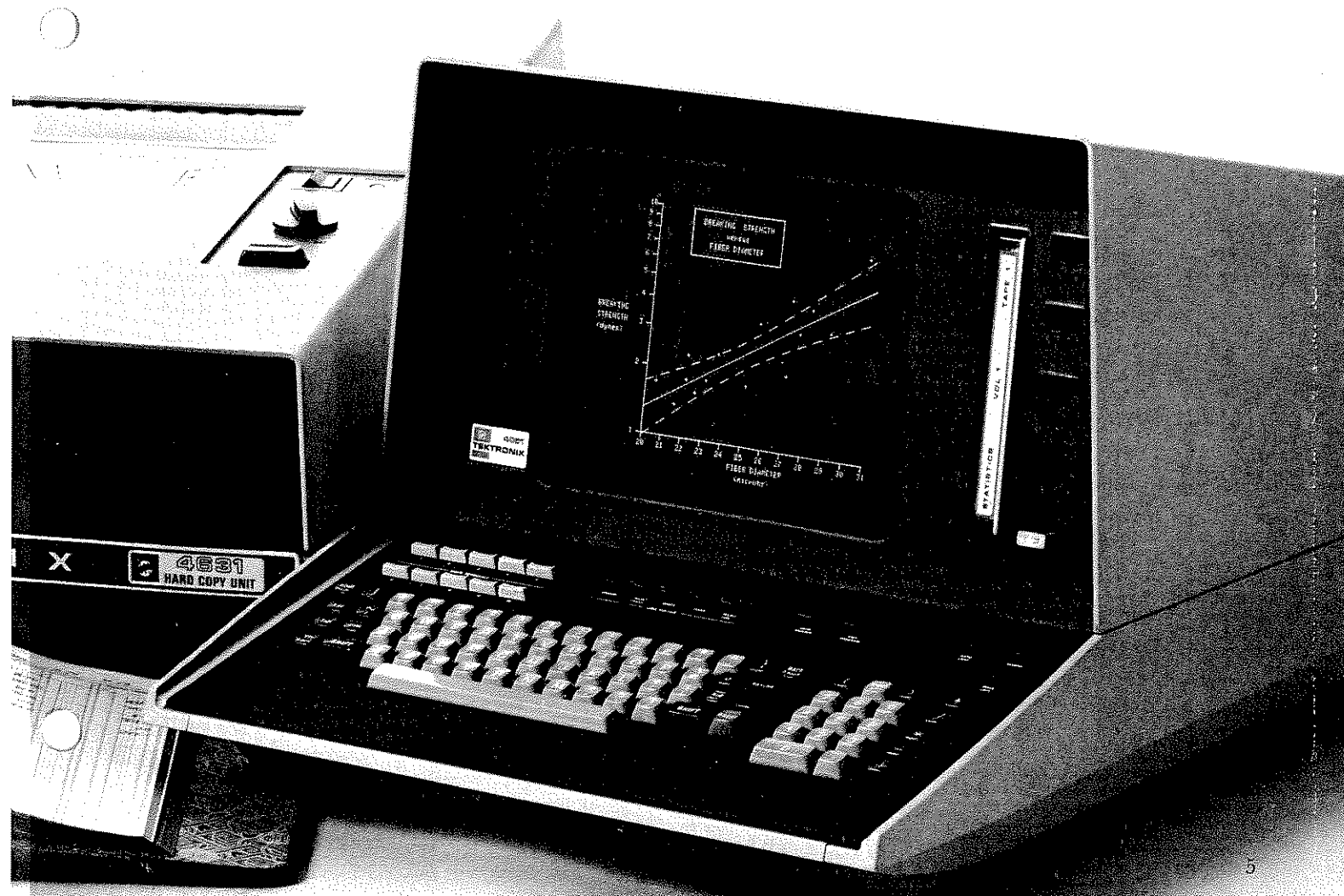

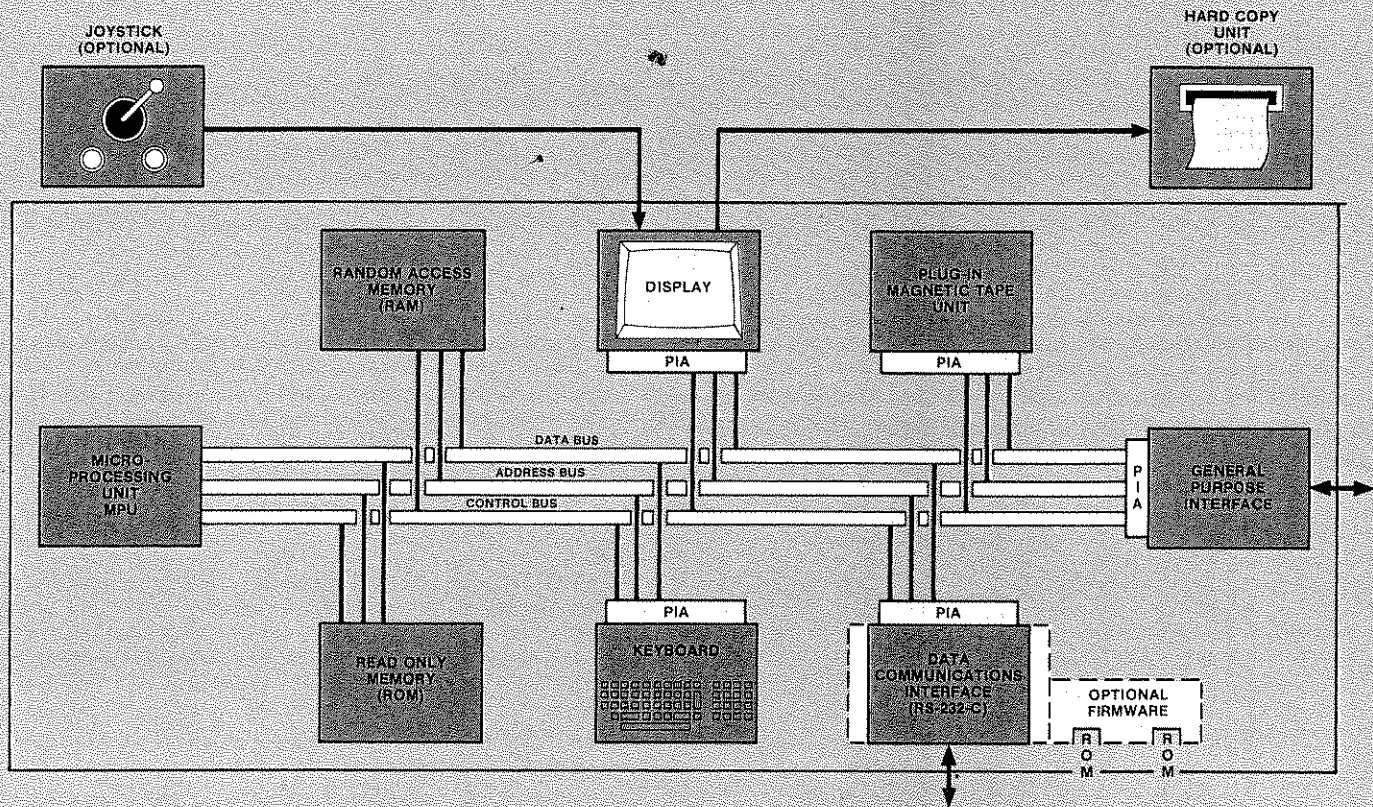

## Functional description

**Microprocessing unit (MPU):** Directs systems operations. Solicits one instruction at a time from the ROM by placing a 16-bit address on the ADDRESS BUS. Decodes and executes the instruction received on the DATA BUS, then fetches the next instruction.

**Read only memory (ROM):** A semiconductor memory with 36K 8-bit byte capacity containing full permanent set of BASIC instructions for the microprocessing unit.

**Random access memory (RAM):** A semiconductor memory for temporary storage of intermediate results of arithmetic operations and BASIC instructions for the microprocessing unit. Contains 8K, 16K, 24K, or 32K 8 byte storage capacity.

**Display:** Rectangular, flat-faced, 11-inch diagonal, direct-view storage crt. Serves as the primary output device for alphanumeric characters, graphs, and line drawings.

**Keyboard:** Primary user input. Statements in BASIC are typed here and each alphanumeric character appears on the crt as it is typed. Appropriate calculations and other responses to each completed statement immediately follow the last keystroke in each statement. Editing keys allow programs to be altered and typing errors to be corrected. User-definable keys make it simple and fast to execute any one of up to 20 pre-programmed sub-routines by pushing the right key.

**Plug-in magnetic tape unit:** A 3M® Data Cartridge with capacity of 300K 8-bit bytes. It allows the operator to make a permanent record of whatever may be stored in the RAM and allows data and programs to be placed in the RAM from the tape.

**General purpose interface:** Provides asynchronous communications with and control of instruments and other peripheral devices designed to be compatible with the IEEE Std 488-1975.

**Data communication interface:** Provides communications with data terminal equipment or data communication equipment designed to be compatible with EIA Standards RS-232-A, B, or C. A second RS232 output-only interface is available for control of printers. Both are optional.

**Optional firmware:** Another part of the Data Communications Interface. Contains receptacles for one or two specialty plug-in ROM's that may be bank-switched under program control to substitute for the internal ROM.

**Peripheral interface adapters (PIA):** IC's that are part of a family of components that includes the MPU, ROM, and RAM. Integral sections of the 4051, such as the Keyboard, Magnetic Tape Unit, GPIB Interface, and Display Unit, are connected to the DATA, ADDRESS, and CONTROL buses through these adapters. Although such sections are integral parts of the 4051 they are considered peripheral with respect to the MPU. Each adapter has unique 16-bit addresses that it responds to when the MPU wants to communicate with the peripheral at those addresses.

**Joystick:** A single handle control for arbitrarily positioning the axis of a graph to a particular point on the crt screen.

**Hard copy unit:** A unit for copying all the data displayed on the crt screen at any particular time.

488-1975, just discussed. The other is optional and is part of what is called a Data Communications Interface. It works with equipment that complies to EIA Standards RS-232 A, B, or C, transmitting data serially one binary bit at a time to such peripherals as line-printers, keyboard terminals, and to host computers.

A Data Communication Interface is made optional to avoid having to charge all customers for both kinds of interface circuits. It is for two-way communications, full duplex, or half duplex, odd, even, or no parity. The baud rate can be either 110, 150, 300, 600, 1200, or 2400 selectable by the user under program control.

### Intelligent graphic terminal

It is easy to see the value of the 4051 as an intelligent terminal. The lion's share of the charges for time-shared computers usually falls into three categories: the number of seconds the computer is working for you, the number of minutes you are connected to the computer, and the number of minutes you are using the phone lines. In most cases the connect charges are the most expensive part of the bill. You can reduce these charges by taking programs off the host or by using the plug-in 4051 tape to transfer data to the host. That saves accessing it through the keyboard at the slow typing speed of the operator. Reductions in connect charges alone will typically pay for a 4051 in less than a year.

When your desk-top machine has access to the vast amount of data that you may store in a large computer, it is a great convenience. That way the data doesn't have to be duplicated in other storage devices and may be updated as frequently as necessary. When you can conveniently give your computer only those problems too big for your desk-top machine you also save money. That becomes an inviting practical possibility if your local terminal has enough intelligence to communicate directly with a host computer. It lets an operator interact only when he needs to, instead of acting as interpreter between his local desk-top machine and a remote wall-to-wall computer.

### The new technology

Several recent technological advancements have made it possible to reduce the size, cost, and complexity of the 4051. The 3M® Data Cartridge is a small, fast, inexpensive magnetic tape cartridge that plugs into the front, containing 300 feet of tape able to store up to 300K 8-bit bytes of data or program instructions. This tape reads from, or writes into, an integrated circuit random access memory that is part of a family of IC's that make up a commercially available micro-computer family. The microprocessing unit that is the head of the family, is also the workhorse of the 4051. The architecture of the whole system is based on it. A wired-in 36K byte read-only memory contains a full, permanent set of instructions that are responsive to BASIC language statements made from the keyboard or the program in progress. Part of that memory is reserved for bank-switching to one or more plug-in ROM's to expand on the primary set of instructions if needed. This feature makes it possible to add special-purpose functions to the machine in response to a particular application problems.

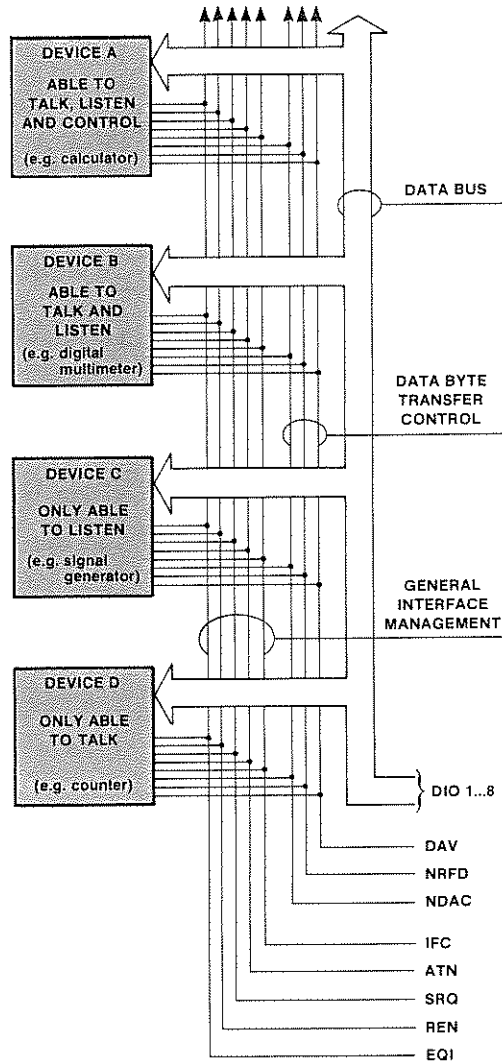
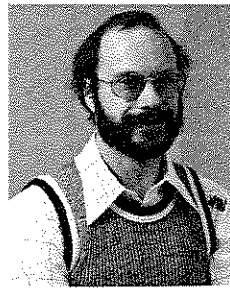

Fig. 1. The 4051 uses the IEEE Standard Digital Interface for Programmable Instrumentation portrayed here.



Tom Needham

*Viewport* *Pointer*  
*Window*  
*Axis* *Draw*  
*Scale* *Redraw*

# Graphing with the 4051 graphic computing system

Until a few years ago the equipment necessary to make graphic displays with a computer was extremely expensive. Then the invention of the bi-stable storage crt at Tektronix led to the development of crt computer terminals and software that gave the world a simple, inexpensive graphic system. Until the 4051 came along, however, graphing required the help of a host computer or calculator. The 4051 has great computational power built-in. It can do computations and display the results graphically all on its own. And it can be made compatible with host computers through an optional RS-232-C standard interface, making it easy to use existing programs and the huge data-bases that some people have on tap at a host computer.

Operating the 4051 so it will display data graphically, as well as with alphanumeric characters, is much easier to learn than you would suppose. If you already know BASIC as a programming language, the task will be especially easy. There are only eleven additional keywords to learn. And once you understand their meaning and function, the whole process of plotting graphs will probably be clearer than it ever was before. If you have used TEKTRONIX PLOT-10 software with a Graphic Computer Terminal you will already be familiar with most of the words. For the 4051 they are:

VIEWPORT	DRAW	AXIS
WINDOW	RDRAW	GIN
SCALE	MOVE	ROTATE
POINTER	RMOVE	

The Cartesian Coordinate system is a way of identifying the location of any point on a plane by first drawing and scaling two straight perpendicular lines in the plane. The lines are called axes. A unique pair of numbers corresponding to the scalar distance between any point and each line, will tell you where that point is.

After scaling the axes with appropriate numbers, the relationship between two variables, X and Y, can be shown graphically by calling one axis X, the other Y. (See Fig. 1)

### The viewport

What things should you decide first when you proceed to make a graph of this kind? For one thing you decide what portion of the available graphing area you want to use. We call that portion the viewport. How would you describe it? You could identify where its four corners are. That would take four pairs of numbers. Or you could identify the four lines that are the sides of the rectangle. For example, if the available graphing area were a sheet of 8½ by 11 inch graph paper consisting of ¼ inch squares, it would have 34 parallel lines running the long direction, and 44 parallel lines running the short direction. Let us say the paper was placed with its long edge down. If you wanted the viewport to be a 5 by 6 inch rectangle with its long edge down, and its lower left corner 3 inches to the right and 2 inches above the lower left corner lines on the paper, you could describe the left, right, bottom, and top edges as lines 12, 36, 8, and 28 respectively.

In the 4051 Graphic Display System we use the Graphic Display Unit concept to define the location of the viewport (see Fig. 3). A Graphic Display Unit is defined

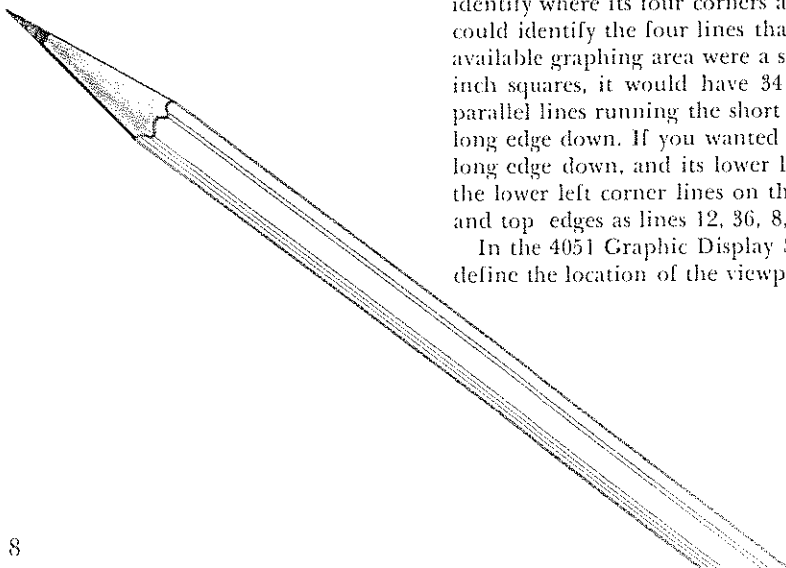



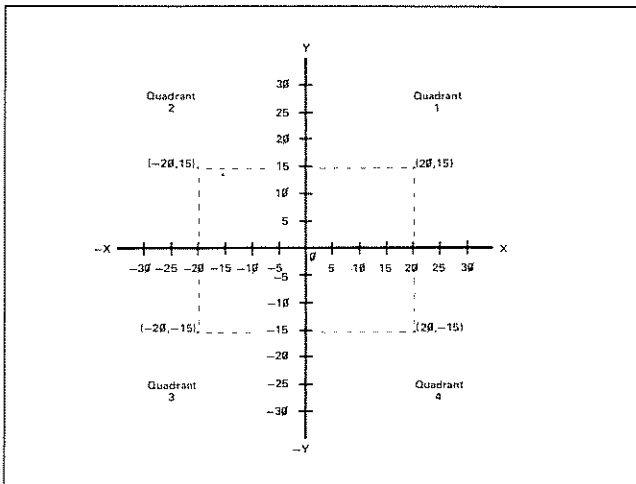

Fig. 1. The Cartesian Coordinate System provides a convenient way to locate any point on a two-dimensional plane. An example is shown below.

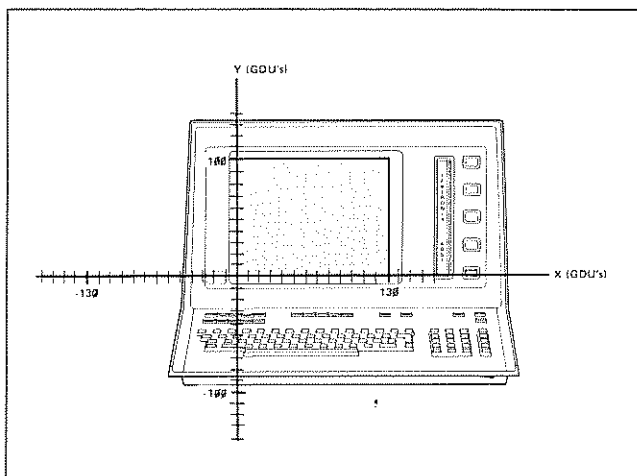

Fig. 2. The drawing surface of the 4051 crt display represents the first quadrant in a Cartesian Coordinate System as illustrated. The lower left corner of the display represents the point of origin. The X and Y axes are marked off in Graphic Display Units to illustrate this concept.

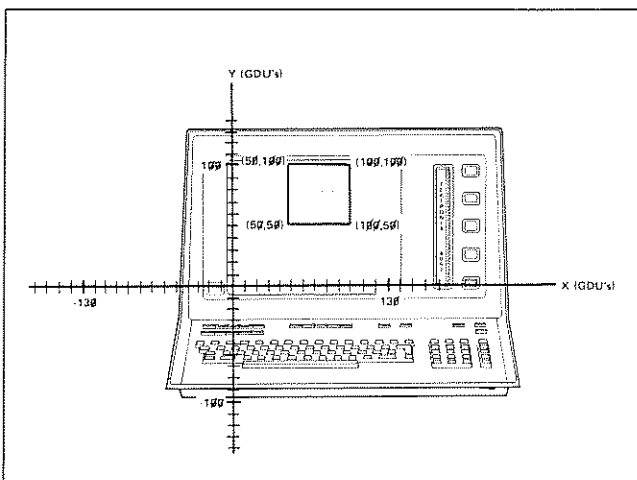

Fig. 3. The VIEWPORT statement controls the boundaries of the drawing surface. Sometimes it is necessary to reduce the size of the drawing surface to leave room for printed messages. The statement for the above viewport would be VIEWPORT 50, 100, 50, 100

to be 1% of the shortest edge length of a given graphic device. It can be thought of as a percentage of a distance rather than as a discrete indivisible unit. For example, a distance of 23.12 GDU's is different from 23.13 GDU's. The use of GDU's permits using the same program to place a graph on the 4051's display screen, an external X-Y plotter, or any future display device in the 4050 family.

It is important to differentiate between Graphic Display Units and the user's data units. The only time you, as a 4051 user, will work with GDU's is when you use the VIEWPORT command to locate your graph on the display device. At all other times you deal with your own data units whether they be fortnights, furlongs, or whatever.

When you use an appropriate set of four numbers with the VIEWPORT statement, the 4051 will automatically confine its graphing within the boundaries described by the numbers. You may still choose to write outside that area with alphanumeric characters, however.

### Resolution

The choices of boundaries for the viewport are limited to 100 by 130 Graphic Display Units when graphing on the 4051 crt. But that should not be understood as being the resolution limits of the 4051. The resolution limits depend primarily on the characteristics of the graphic readout device. When the readout device is the 4051 crt, the resolution limit is determined by 10-bit digital-to-analog converters in the 4051. This translates to 1024 increments in the horizontal direction and 780 increments vertically. When the 4051 addresses an external graphic readout device, like an X-Y digital plotter, resolution will be limited by that device.

### The window and the scale

The Cartesian Coordinate graphing world of the 4051 extends to numbers as high as  $10^{308}$  for points in all four quadrants. That is an extremely vast plane compared to the portion occupied by any ordinary graph. For most data it is much more than adequate. What portion of that vast plane the data you want to examine fits into can be regarded as the window you wish to look at. When the WINDOW statement in the 4051 is followed by the minimum and maximum values for the horizontal and vertical data that you want to graph, you are prepared to fill the viewport with the graphic data you want. It doesn't matter what units the data is in, or whether some data entered may fall outside the limits. Any graphic data entered that falls outside the limits will be automatically ignored, but the rest will be displayed.

An alternate way of fitting the data you want to view, to the viewport where it will be displayed, is to use the SCALE statement. Then the graphic data is scaled down to the area for the graph by specifying how many user units fit into one Graphic Display Unit.

### Axis and tic marks

Once the minimum and maximum values for each axis has been identified, the window is defined and the location of each axis can be determined. The AXIS command automatically draws horizontal and vertical axes, with tic marks if desired.

If the range of numbers on either axis extends both sides of zero, the other axis line will be drawn through the point corresponding to zero. Otherwise, when all values are positive, the axis intercept point will be at the lower left corner of the window area. The 4051 will draw axes in the customary way simply by default, once it has the window informa-

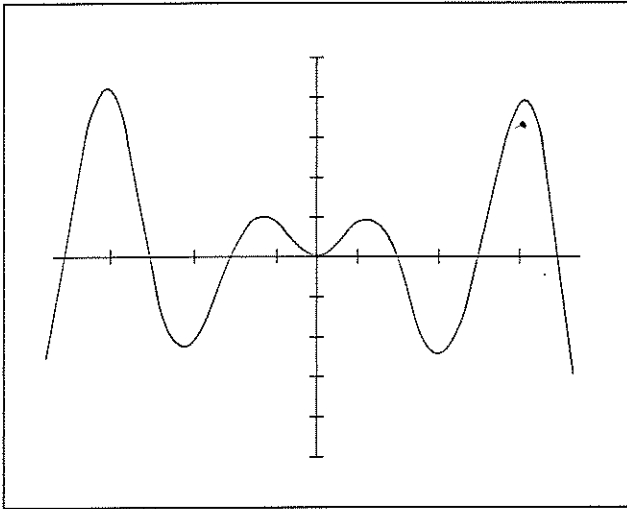

Fig. 4. The ease with which graphics can be generated on the 4051 is illustrated by this graph which was drawn using just seven program steps.

tion and receives the `AXIS` statement. Tic marks on one or both axes will be added automatically if the `AXIS` statement is followed by numbers for the desired size of the increment. The tic marks are automatically spaced and located on each axis to correspond with the user's units for each axis. Numbers can be added adjacent to the tic marks later if desired. Logarithmic axes, however, require a different technique.

#### Absolute and relative moves and draws

In one sense you draw a graph with the 4051 very much the same way as you would by hand, with a piece of chalk on a blackboard. The chalk can be moved from one point to another without drawing a line, if you lift it. On the 4051, the crt beam is turned off for `MOVE` statements and turned on for `DRAW` statements. The same is true for relative move (`RMOVE`) and relative draw (`RDRAW`) statements. The difference between absolute and relative moves is that absolute moves are stated with respect to the last point the beam was moved to. The same is true about the difference between absolute and relative draws.

A line is drawn each time a simple `DRAW` command is executed. From that, it is easy to make the assumption that the 4051 takes a lot of time to draw a complex curve. But not so. By storing data points in two matrices, even a long series of draws is executed very rapidly. The array variables representing the two matrices are specified in the `DRAW` statement.

How really simple it is to draw a complex graph on the 4051 is best illustrated by considering the graph in Fig. 4. It took just seven program steps to construct the graph:

```
100 VIEWPORT 10, 120, 10, 90
110 WINDOW -10, 10, -10, 10
120 AXIS PI/2,2
130 MOVE -10, 10*SIN (10)
140 FOR I=10 to 10 STEP 0.2
150 DRAW I, I*SIN (I)
160 NEXT I
```

The `VIEWPORT` statement was used to reduce the size of the graph on the display. If we had wanted the graph to fill the screen, the `VIEWPORT` statement could have been

omitted as the viewport parameters are automatically set to 0, 130, 0, 100 by default on system power up and after the execution of an `INIT` statement.

#### Dot matrix, pointer, gin

When the 4051 crt is producing an alphanumeric or graphic readout, the position of the last character or point is identified by a blinking marker. The marker is a small 5 by 8 dot matrix the same size as the outer limits of an alphanumeric character. The `POINTER` command places a small arrow on-screen. The position of the arrow can be controlled by an optional Joystick, or selected by the user definable keys. Using the `GIN` command, the X-Y coordinates of the point selected by the arrow are assigned to two variables and can be used by a program to keep track of its position.

#### About speed

Everyone wants to know how fast his computer or calculator is. It is a natural, important question that is very difficult to answer satisfactorily. The same question applies to the 4051, and is even a little harder to answer. If the 4051 is controlling peripheral instruments and is waiting for data from one of them before finishing a computation, it would be misleading to talk about how fast or how slow the 4051 was. On the other hand, if it is merely calculating 50 factorial, or doing a similar bench mark computation, you would like to know how the time it takes to perform this function compares with other similar equipment. But what are you to conclude when some of the bench marks are met better by equipment A than by equipment B, but other bench marks are met better by B than by A? You can start by being selective about which bench marks are more typical of your work. That is not a bad way. It leads you to the conclusion that the speed question may be answered satisfactorily by comparisons on each job. The main thing we want to know is whether a machine is fast enough for our job. If, on the average, it is slower than what we are used to, it follows that it should be more economical to be worthy of consideration. If, on the other hand, it does the things you want it to do, as fast as you expect, and has the price and advantages you can't equal elsewhere, it is fast enough.

For most jobs, the 4051 speed is comparable to a mini-computer executing a BASIC program. The graphic capability, ease of programming, and low cost of the 4051 Graphic Computing System can be important factors in solving your application problems in a more effective and productive way. It certainly bears looking into. 



Fred Telewski

## A high-stability 100 KHz to 1.8 GHz tracking generator

Tracking generators, working with spectrum analyzers, offer significant advantages over other frequency-response measurement techniques. A continuous, well-defined display, freedom from distortion, wide dynamic range, and operating ease are all benefits derived from using a tracking generator/spectrum analyzer system.

These advantages arise from the fact that the tracking generator's output frequency is synthesized from the spectrum analyzer's local oscillators. The tracking generator's output frequency is always the same as the instantaneous frequency of the analyzer, and the frequency stability is essentially equal to that of the analyzer.

High-resolution, high-stability measurements up to 110 MHz have been possible for some time using tracking generator/spectrum analyzer systems. Now, two new tracking generators, the TR 501 and TR 502, designed to work with the 7L12 or 7L13 Spectrum Analyzer, extend this measurement capability to 1.8 GHz. The TR 501 and TR 502 are essentially the same instrument with the exception of the output attenuators and logic interface in the TR 502. For purposes of brevity we will confine this discussion to the TR 502.

### Design goals

The primary design goal for the TR 502 was to build a companion tracking generator for the 7L13 Spectrum Analyzer, whose output would faithfully track the 7L13, maintaining 10 Hz FM stability and display flatness over the entire 100 KHz to 1.8 GHz range. This promised to be no easy task. Another goal was to package the unit in a two-wide plug-in to be housed in, and powered by, a TM 500 Mainframe. This would open the door to added measurement capability through working with other TM 500 plug-ins. For example, by plugging a DC 502 Option 7 Digital Counter into the TM 500 Mainframe powering the TR 502 you can make selective frequency measurements, with counter accuracy, up to 550 MHz. We'll discuss this in greater detail later. Now let's look at how the TR 502 works.

### Theory of operation

The spectrum analyzer (7L12, 7L13) up-converts its input signal frequency to a 1st IF of 2.095 GHz by mixing with the 1st LO (local oscillator). It then down-converts the 2.095 GHz to an IF of 105 MHz by mixing it with the 2nd LO frequency of 2.2 GHz.

The TR 502 Tracking Generator reverses this sequence. Referring to the block diagram in Figure 2 we see that

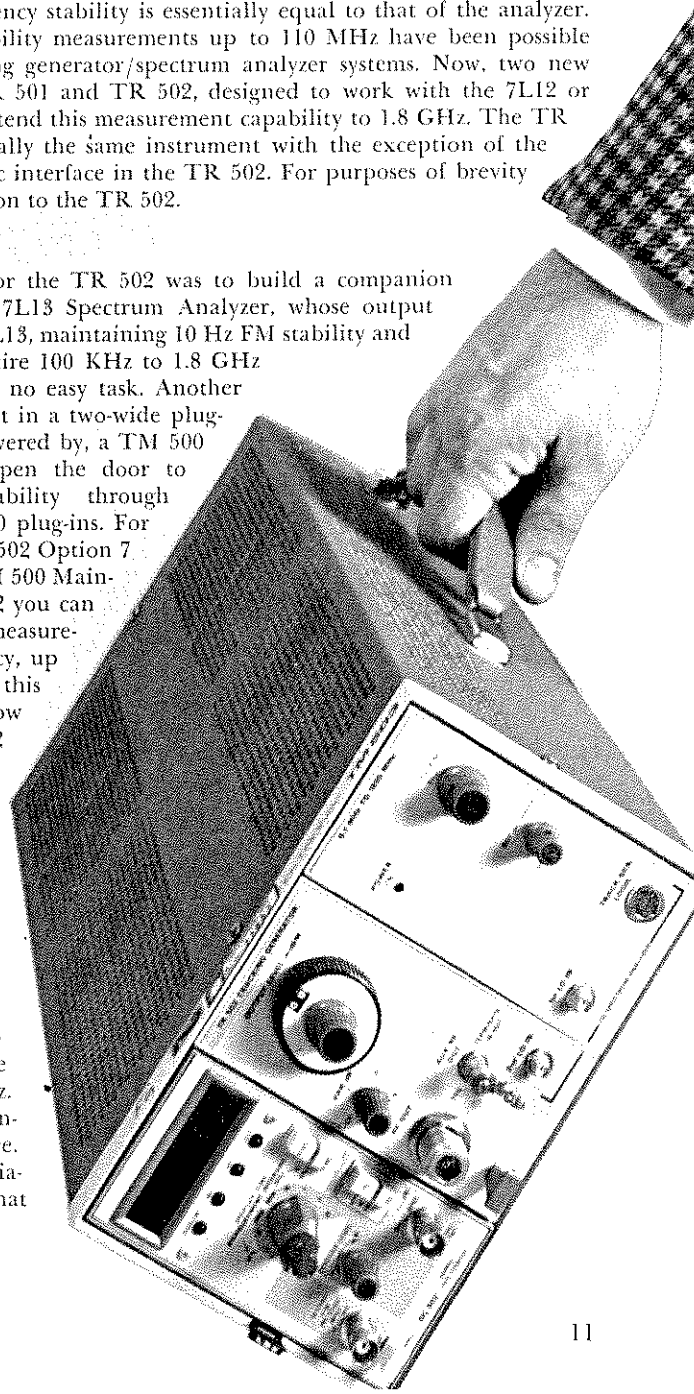

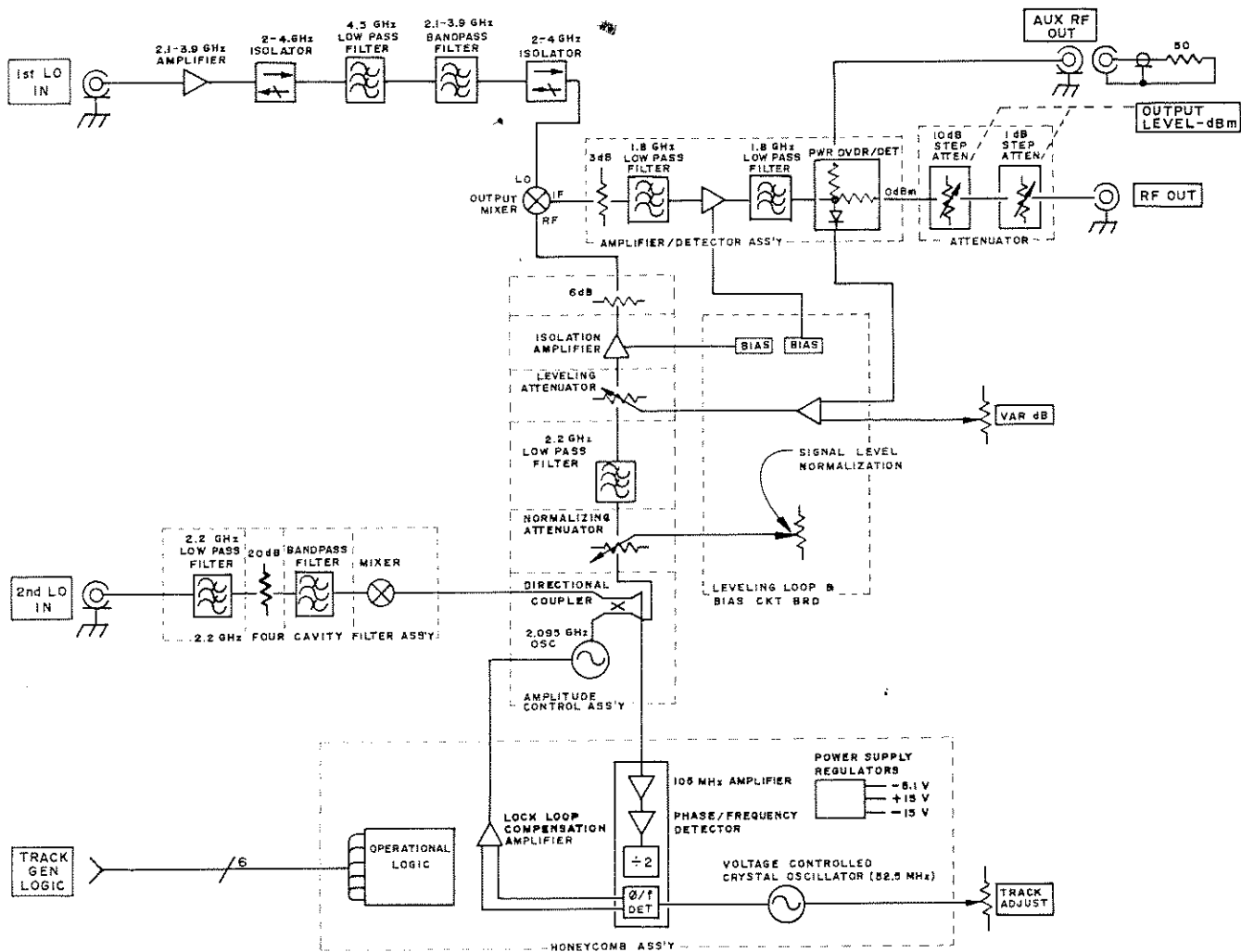

Fig. 1. Block diagram of the TR 502 Tracking Generator.

the 1st LO and 2nd LO from the spectrum analyzer are fed into the TR 502. A voltage controlled oscillator running at 2.095 GHz is mixed with the 2nd LO input of 2.2 GHz. The resultant 105 MHz difference frequency is used in a phase lock loop to keep the 2.095 GHz oscillator in step with the 2nd LO.

The 1st LO input signal ranges from 2.1 to 3.9 GHz and may be either a constant or swept frequency depending on the operating mode of the spectrum analyzer. The 1st LO signal is mixed with the 2.095 GHz signal, with the resultant lower difference frequency becoming the output signal frequency of the tracking generator. The output signal is filtered, amplified, automatically leveled, and applied through a step attenuator to the output connector of the tracking generator. Now let's look at the block diagram in greater detail.

### The 1st LO signal

The input signal from the spectrum analyzer 1st LO is amplified to a level of about 6 mW by the 2.1 GHz to 3.9 GHz limiting amplifier. From the limiting amplifier the signal passes through a series of isolators and filters to the output mixer. The LO signal level at the output mixer is about 5 mW.

Several different types of filters are used in the TR 502, each chosen for its particular characteristics. The 4.5 GHz low-pass filter is a tubular type, while the 2.1 to 3.9 GHz bandpass filter is a 16-element interdigital filter. An interesting side-point is that in manufacturing the interdigital filter, combined tolerances are held to less than 0.001 inch to eliminate the need for tuning the filter.

### The role of the 2nd LO

Turning to the 2nd LO input, we see that the signal passes through a 20 dB attenuator, to a 2.2 GHz low-pass filter, and thence to a two-diode balanced mixer. All of which are housed in the four-cavity bandpass filter assembly pictured in Fig. 2.

The 2.2 GHz signal is mixed with the 2.095 GHz oscillator signal to generate the 105 MHz signal used to phase lock the 2.095 GHz oscillator. The 105 MHz signal is divided by two and compared to a 52.5 MHz crystal-controlled oscillator to develop the compensating phase lock signal.

The 2.095 GHz oscillator uses a resonant micro-strip line in the collector of a common-base transistor oscillator to establish its frequency. It is tuned over a range of about 20 MHz by varying the collector voltage to change the collector-to-base capacitance.

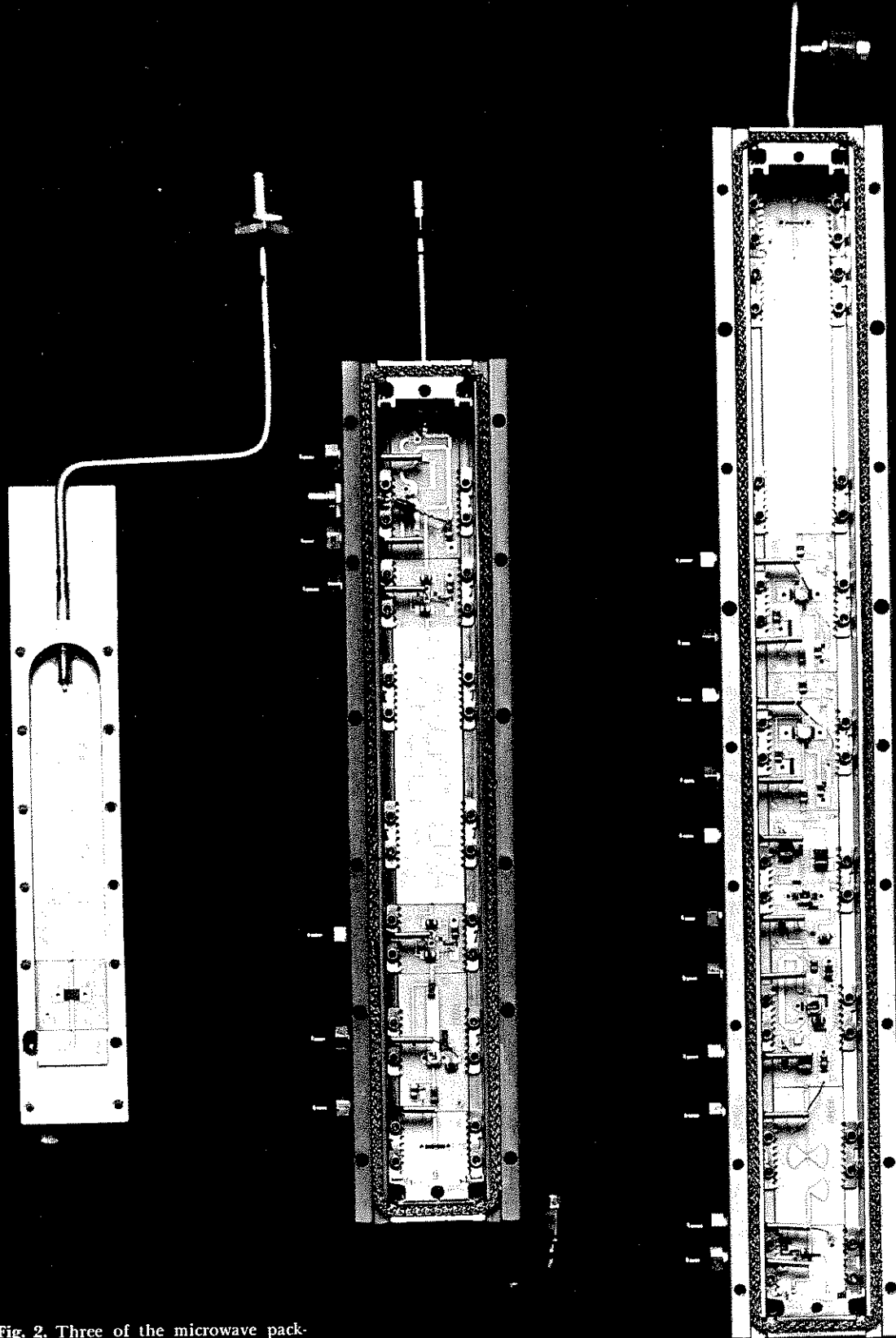

Fig. 2. Three of the microwave packages used in the TR 502. At left is the four-cavity bandpass filter assembly showing the 20 dB attenuator and 2.2 GHz low-pass filter. At center is the assembly containing the 2.095 GHz oscillator, normalizing, leveling, and 6 dB attenuators, low-pass filter and the isolation amplifier. The assembly at right houses the output amplifier and associated filters and attenuators.

The 2.095 GHz signal passes through a directional coupler to a PIN-diode attenuator where initial adjustment of the output level range is made. The signal then passes through a 2.2 GHz low pass filter to a second PIN-diode attenuator, where automatic leveling of the TR 502 output signal occurs. Since the IF amplitude level out of the mixer tracks the rf signal level (with about 6 to 8 dB of loss), we control output signal amplitude by controlling the rf signal level into the mixer. From the leveling attenuator, the rf signal passes through an isolation amplifier providing about 7 dB of gain and greater than 20 dB of reverse isolation. Its output drives the output mixer through a 6 dB attenuator.

The 2.095 GHz oscillator, normalizing, leveling, and 6 dB attenuators, the low-pass filter, and isolation amplifier are constructed in a comprehensive hybrid and microwave package (dubbed CHAMP by the project engineers). This type of construction offers tremendous flexibility and economy compared to earlier techniques.

### The output amplifier

The output amplifier section also uses the same type of construction (See Fig. 2). The lower conversion frequencies from the output mixer pass through a 3 dB attenuator and 1.8 GHz low-pass filter to the wideband amplifier. The 3 dB attenuator provides a wideband termination for the mixer. The 1.8 GHz low-pass filter is an elliptic function filter, flat to 1.8 GHz and rolling off with a sharp notch at 2.095 GHz. The 0 to 1.8 GHz signal is amplified by about 40 dB by the four-stage wideband amplifier, then passes through another 1.8 GHz low-pass filter to the power divider and level detector. Each stage of the output amplifier is supplied by a separate bias supply. The bias circuits and amplifiers are connected as a feedback loop with the collector load current of the amplifier sensed by the input resistor to the operational amplifier. This voltage is compared to a +10V reference. The operational amplifier output drives the base of the rf amplifier to set the bias, holding the collector voltage constant at +10 volts. The 1.8 GHz low-pass filter following the amplifier attenuates frequencies above 1.8 GHz which may be generated by the amplifier.

The level detector is a directional peak detector that senses the forward power but not the reflected or reverse power. Forward power is independent of the load. The output attenuator provides calibrated 1 and 10 dB steps of output power over the range of 0 dBm to -59 dBm, with a variable control adding up to 2 dB of attenuation between steps. The output amplitude is flat within  $\pm 0.5$  dB from 100 KHz to 1.8 GHz. The TR 502/7L13 system is flat within  $\pm 2$  dB over the same frequency range.

### Operational innovations

We mentioned earlier that the TR 502 could be used with the DC 502 Option 7 Digital Counter for making accurate frequency measurements. Through an innovative technique, using dual rf outputs, frequency can be measured accurately at spectrum analyzer sensitivities. The theory of this powerful convenience is very simple. The sweep generator in the analyzer stops at mid-screen, and a command is sent through the tracking generator to the counter to count. When counting is completed (in 10 or 100 ms), the counter commands the analyzer to continue the sweep. The user sees the momentary pause as a bright dot at mid-screen. The count time, and hence the resolution of the measurement, is determined by the phase lock mode of the analyzer.

When the analyzer is operated in manual, external sweep, or a non-sweep mode, the counter will count continuously.

The DOT INTENSITY control on the TR 502 enables the logic circuitry for counter measurements and sets the dot intensity on the analyzer display.

### Mechanical innovations

The bulk of the rf circuitry is housed in the left-hand portion of the plug-in. We have already mentioned the comprehensive hybrid and microwave package used for the 2.095 GHz oscillator and associated signal path components, and the 0 to 1.8 GHz amplifier. Pretesting of the individual substrates in these units saves considerable final test time and substantially reduces the likelihood of encountering a defective unit in final test. The cost of repairing these units is also minimal since a failure does not necessitate replacing the entire unit. The defective substrate can be quickly isolated and replaced at a fraction of the cost of the entire assembly. The right hand half of the plug-in contains a 6-compartment honeycomb casting that houses the 105 MHz amplifier, 52.5 MHz oscillator, the  $\phi/f$  detector, and the bias and leveling circuits. Excellent shielding, good rf environment, ruggedness, and good serviceability are provided by the honeycomb structure.

### Summary

The TR502/7L13 Tracking Generator, Spectrum Analyzer system provides highly accurate frequency response measurements over the range of 100 KHz to 1.8 GHz with resolution to 30 Hz. This narrow bandwidth resolution yields a wide dynamic range ( $> 110$  dB) permitting measurements well down on the skirts of device responses. The system can be used with the DC 502 Option 7 Digital Counter to select and accurately determine frequencies up to 500 MHz. As a CW source, the TR 502/7L13 offers a stability of 10 Hz when the analyzer is in a zero-span (non-sweep) mode.

### Acknowledgements

Fred Telewski was Program Manager for the TR 502 project. Assisting in electrical design were Glenn Bateman, Michael McMahon, David Morton, and Phillip Snow. The mechanical design team included Carlos Beeck, Jack McCabe, and Leighton Whitsett.

For complete specifications on the TR 502 we invite you to return the inquiry card accompanying this issue of Tekscope.



Dave McCullough

# Delayed gate aids oscilloscope digital measurements

The oscilloscope is basically an analog measurement device. We say "basically" because, with the introduction of digital plug-ins for the TEKTRONIX 7000-Series Oscilloscopes, digital measurements were added to the oscilloscope's repertoire.

One of the major advantages of making digital measurements with an oscilloscope is the ability to view, and select, the precise portion of the signal to be measured. The dual time base capabilities of a plug-in like the 7B53A, with Delayed Gate output, permit some highly selective digital measurements. Typical applications include accurate time measurements between two points on the same waveform, an accurate count of events in a sudden burst, or accurate voltage sampling between any two points on a waveform. Figures 1 through 3 illustrate these measurements. In each instance, the Delayed Gate is used to control the digital plug-in.

The brightened portion of the trace corresponds to the time and duration of the

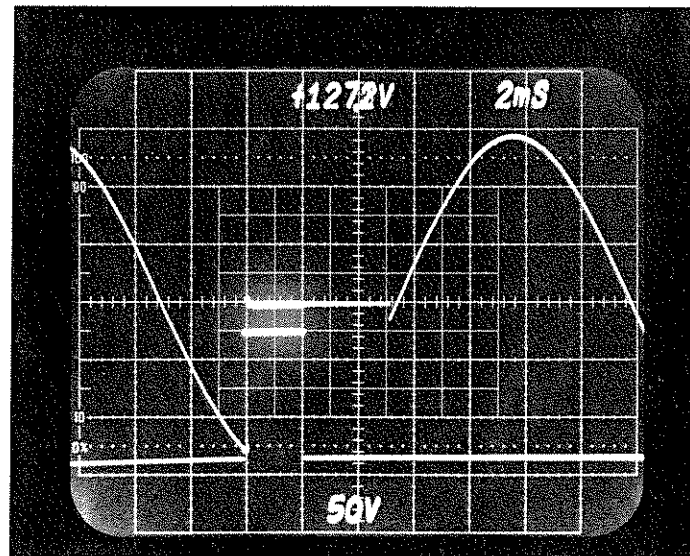

Fig. 1. The 7D12 A/D converter plug-in with an M2 Sample/Hold Module measures the voltage excursion on the anode of a silicon-controlled rectifier at the instant it is gated on. The period of measurement is selected by the Delayed Gate, displayed on the lower trace.

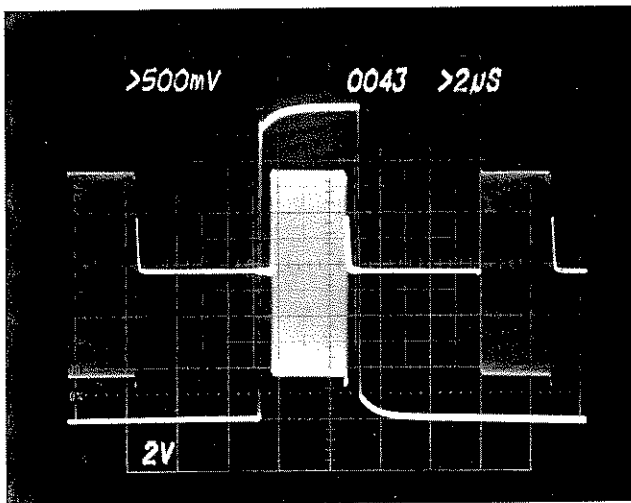

Fig. 2. The number of pulses in a burst are readily counted by bracketing the burst with the Delayed Gate to gate a digital counter plug-in such as the 7D14 or 7D15.

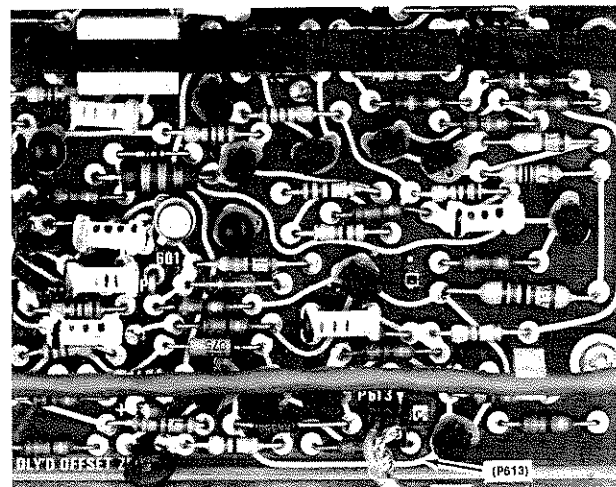
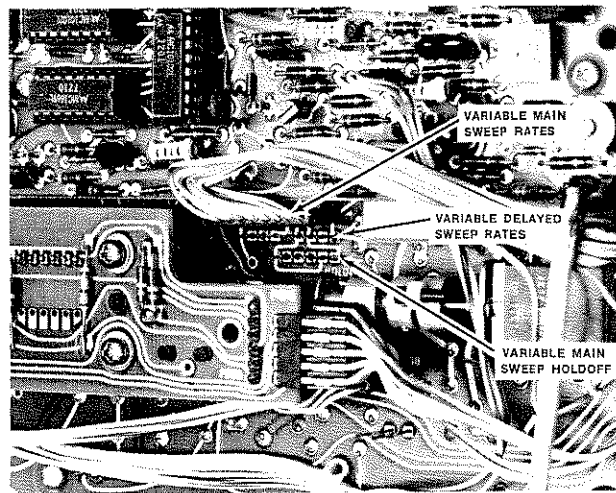

Fig. 4. The function of the front-panel VARIABLE control is determined by the position of the Variable Selector Connector shown in the upper photo. The Delayed Gate Out Connector shown in the lower photo applies the Delayed Gate Out to the DLYD TRIG IN connector.

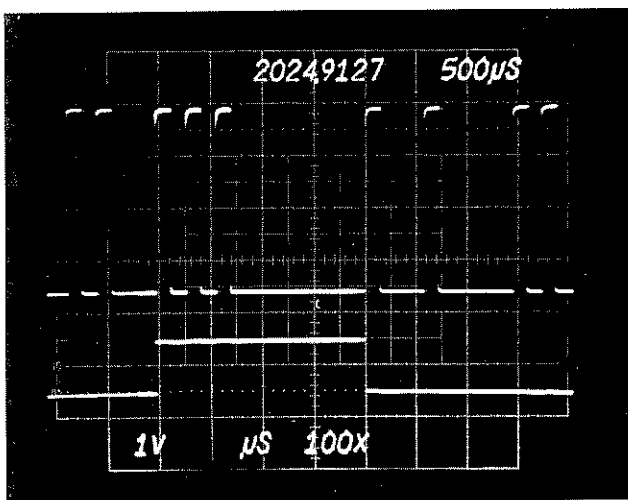

Fig. 3. The time between two selected events can be accurately measured by using the Delayed Gate to start and stop a counter such as the 7D15 Universal Counter/Timer. In this photo CH A of the 7D15 is armed by the Delayed Gate rise and CH B is armed by the fall. The count is started by the rise of the third pulse and stopped by the rise of the sixth pulse. The lower trace is the 7D15 pseudo gate display showing the counting interval.

Delayed Gate, and to the period during which the digital measurement will be made. The start of the Delayed Gate is controlled by the Delay Time Multiplier, while gate width is selected by the Delayed Sweep TIME/DIV (for the coarse adjustment). The Delayed Sweep VARIABLE serves as the fine width adjustment.

#### Internal GATE and VARIABLE selection

To simplify operation and reduce front-panel complexity yet maintain versatility, some controls and connectors on the 7B53A front panel are made to perform dual functions, as selected internally. Figure 4 shows the VARIABLE functions available by relocating the Variable Selector Connector, and the Delayed Gate Out Connector that applies the Delayed Gate Out to the DLYD TRIG IN connector. It takes just a few minutes to make the changes needed to obtain a variable Delayed Gate at the front-panel.

#### Summary

Digital measurements on analog signals are greatly enhanced by combining digital instruments with an oscilloscope. The Delayed Gate, available with most dual time bases, is a powerful tool for making precise gated digital measurements.



# Servicescope



Ron Lang

## Replacing probe tips, bodies, and boots

Oscilloscope probes take a beating. Not because scope users abuse them, but because they get a lot of use. And since today's circuitry contains many small components mounted in as little space as possible, probes have to be physically small to work on them. The probe cable also must be small to minimize the weight we hang on the circuits.

The smaller the probe and cable, the more subject they are to damage. When a probe is damaged, it can often be repaired for much less than the cost of replacing it. Here are some service hints that will help you make those repairs.

### Tips

Most new TEKTRONIX probes accommodate small interchangeable slip-on tips. But many of us make a practice of using the probe without a slip-on tip and that makes the unprotected built-in tip subject to breaking or bending. Trying to straighten a bent tip will sometimes break it. Then either the built-in tip or the entire probe body must be replaced. The built-in tips are less expensive but on some probes they are not replaceable. It is simple to tell which may be replaced, however. Unless the cylindrical metal ground sleeve extends all the way to the edge of the tip-holder the cylindrical metal ground sleeve extends all the way to the edge of the tip-holder the point is replaceable. See Figure 1a and 1b.

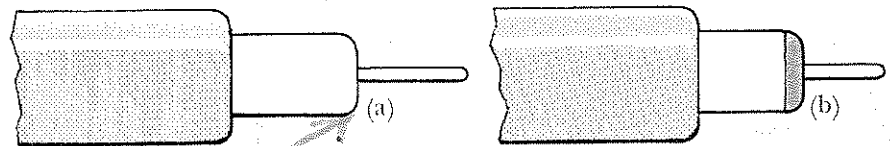

Fig. 1. Two types of probe tips commonly used on TEKTRONIX probes. The one at left is not replaceable, while the one at right is.

There are two types of built-in tips but they are not interchangeable. The following table shows which tip is for which probes.

Use tip 206-0187-00 with these 200-Series scope probes:

010-0262-01  
010-0262-02

And with this probe:

P6055

Use tip 206-0191-01 with these 200-Series scope probes:

010-0262-03  
010-0262-04  
010-0262-05

And with these probes:

HZ-25	P6063A
P6049B	P6065A
P6053B	P6075A
P6062A	

Two different methods can be used to remove replaceable tips. The first method, which can be used for all replaceable tips, is pictured in Fig. 2. A sharp pair of wire

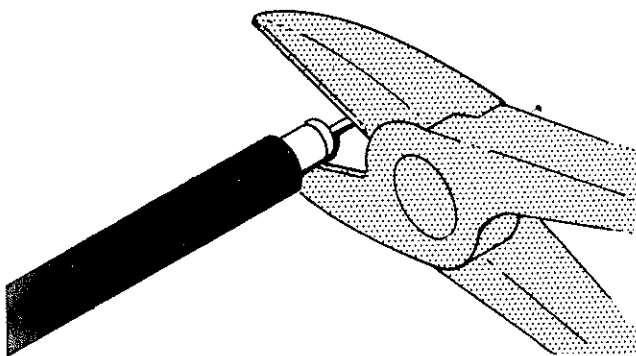

Fig. 2. The replaceable probe tip can be removed as illustrated here. Care should be taken not to squeeze or nick the grounding sleeve.

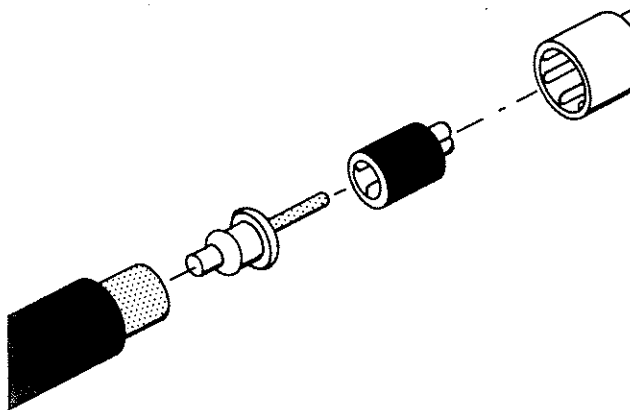

Fig. 3. The replacement tip can be pressed into position by tapping sharply with a 3/16" hollow shaft nut driver (or similar tool) as shown here.

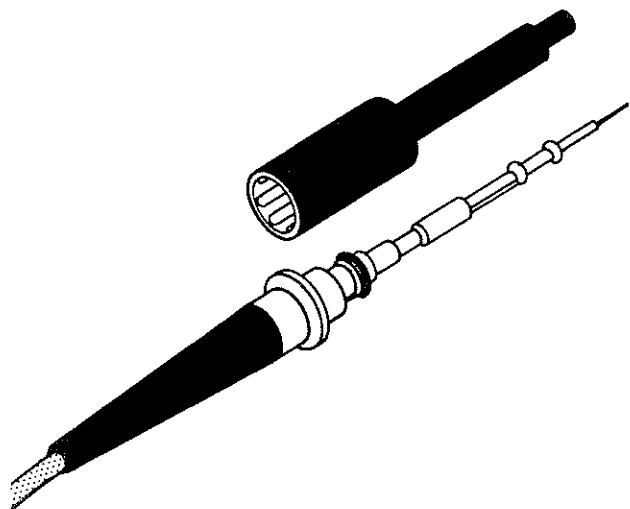

Fig. 4. The new style probe body can be distinguished from the old style by noting the six raised ribs inside the end near the threads.

cutters is used to separate the plastic tip from the grounding sleeve. Gripping the probe tip between the plastic and grounding sleeve with the cutters, pull the tip free from the grounding sleeve with a sideways rocking motion of the cutters. Care should be taken not to squeeze or nick the

grounding sleeve.

\* The second method can be used for removing some tips, and avoids the possibility of damaging the grounding sleeve with the cutters. It involves using a small rod to drive the tip out from the rear. Different size rods are needed for different probes. For the following probes a rod with a diameter of about 0.15 inches should be used:

P6049B	P6055
P6053B	P6065A
P6054B	P6075A

For the following 200-Series scope probes use a rod with a diameter of about 0.05 inches:

010-0262-00
010-0262-01
010-0262-02

Other replaceable tips cannot be removed with a rod.

To remove a tip with a rod, insert the rod into the rear of the probe body making sure that the rod is seated on the plastic tip-holder, and drive the holder out.

To replace a probe tip, use the procedure shown in Fig. 3. The IC test tip is placed over the probe tip, and a 3/16" hollow shaft nut driver is used to press the tip into position.

#### Bodies

The screw-on probe bodies on some of the early models of the probes listed below ~~may loosen and cause intermittent~~ contacts. When that happens a new style body should be ordered. A new style body may be distinguished from the old style by ~~six raised ribs~~ inside the end near the threads in the new style. See Fig. 4.

For—

P6049A	use	204-0447-03
P6053A	use	204-0579-00
P6054A	use	204-0579-03
P6065A	use	204-0579-01
P6075A	use	204-0579-02

#### Boots

If you are encountering probe cable breakage near the strain relief boot on the scope-end of the following probes you should know that replacement cable assemblies have longer boots (50 mm) making the new assemblies more reliable. Here are the probes and assembly numbers:

P6053A	3.5 ft 010-6053-01.....	use	175-1101-01
	6.0 ft 010-6053-03.....	use	175-1139-01
	9.0 ft 010-6053-05.....	use	175-1311-00
P6053B	3.5 ft 010-6053-11.....	use	175-1435-00
	6.0 ft 010-6053-13.....	use	175-1139-02
	9.0 ft 010-6053-15.....	use	175-1311-01
P6054A	3.5 ft 010-6054-11.....	use	175-1173-03
	6.0 ft 010-6054-13.....	use	175-1383-01
	9.0 ft 010-6054-15.....	use	175-1400-01
P6061	3.5 ft 010-6061-01.....	use	175-1173-02
	6.0 ft 010-6061-03.....	use	175-1174-01
	9.0 ft 010-6061-05.....	use	175-1205-01
P6065A	6.0 ft 010-6065-13.....	use	175-1383-01
	9.0 ft 010-6065-15.....	use	175-1400-01
P6075A	6.0 ft 010-6075-13.....	use	175-1383-01

Replacement parts may be ordered through your local Tektronix Field Office or Representative.

# New products New products New products

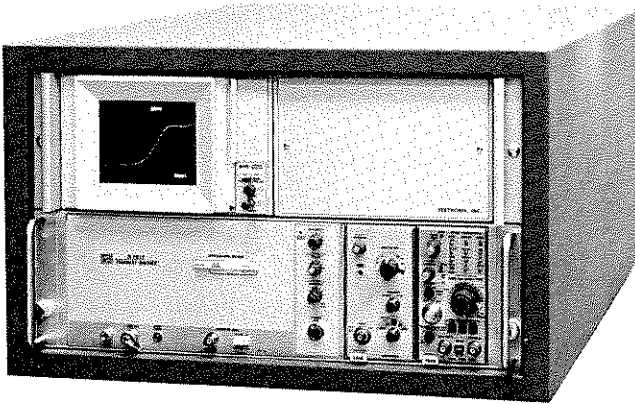

## WP2005 Waveform Digitizing Instrument

The WP2005 Waveform Digitizing Instrument is a high-speed waveform viewing package that features bright, stored displays of transient or repetitive waveforms. Its high performance includes bandwidth of 500 MHz at 10mV/div or 1 GHz at 4V/div (using the 7A21N Direct Access Unit), sweep speeds to 0.5 ns/div, and stored writing speed to 8,000 div/ $\mu$ s. The new 605 Storage Monitor with its bright, variable persistence storage display makes it feasible to offer the WP2005 without the 1350 Memory Display Unit used in other WDI viewing packages. The result is the least expensive viewing package for those wishing only to see the shape of a transient, or to overlay successive transients and observe changes or anomalies.

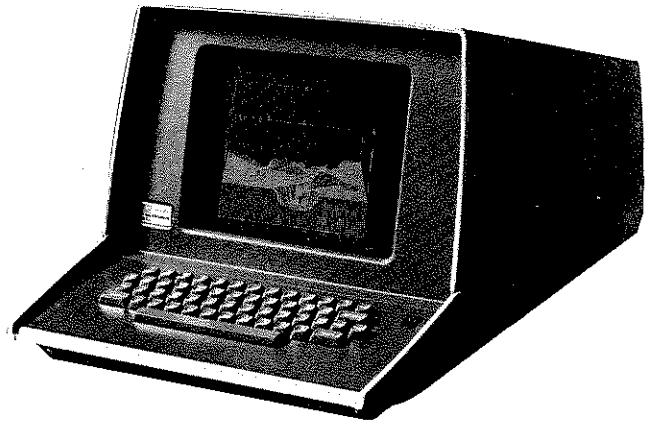

## 4006-1 Computer Display Terminal

The new TEKTRONIX 4006-1 Computer Display Terminal brings graphic display capability right to your desk top at a new low cost. The 11-inch storage tube provides crisp, clear displays with 800,000 viewable points (1024X by 780Y). It has an on-screen capacity of 2590 alphanumeric characters. You can transmit or receive data at selectable rates of 75 to 4800 baud.

The 4006-1 is supported by extensive software products, and is compatible with the 4631 Hard Copy Unit for dry, high-quality, 8 $\frac{1}{2}$  x 11-inch copies of any information displayed on the 4006-1 screen. The Digital Cartridge Tape Recorder, a low-cost off-line data storage device, is also compatible with the 4006-1. For more complete details on the 4006-1 use the reply card accompanying Tekscope.

Copyright © 1975, Tektronix, Inc. All rights reserved. Printed in U.S.A. Foreign and U.S.A. Products of Tektronix, Inc. are covered by U.S.A. and Foreign Patents and/or Patents Pending. Information in this publication supersedes all previously published material. Specification and price change privileges reserved. TEKTRONIX, SCOPE-MOBILE, TELE-EQUIPMENT, and  are registered trademarks of Tektronix, Inc., P. O. Box 500, Beaverton, Oregon 97077, Phone: (Area Code 503) 644-0161, 910-467-8708, Cable: TEKTRONIX. Overseas Distributors in over 40 Countries.

# Newliterature Newliterature Newliterature

**A new TEKTRONIX TM 500 Catalog is now available.** It contains the most up-to-date data on new TM 500 products, such as the SC 502 dual-trace oscilloscope and TM 515 Traveler Mainframes, and is the most complete compilation of performance specifications for the entire line. Also included are thirteen articles discussing the application of TM 500 instrumentation in areas varying from field servicing of digital equipment to the vibration analysis of turbines.

**A new 32-page booklet entitled "Portable Oscilloscopes For all your Servicing Needs"** provides complete specifications on Tektronix extensive line of portable oscilloscopes. Included is a discussion of the factors to be considered in selecting the portable best suited to your needs.

**Curve Tracer Application Note 48K1.0 entitled "Testing Optoisolators"** describes the use of the TEKTRONIX 577/177 Curve Tracer to check most of the important optoisolator specifications. Testing these devices before they are installed can save many costly hours of troubleshooting in the prototype, productions, and test stages of manufacturing.

To receive copies of this literature use the inquiry card accompanying Tekscope.

A-3261

TEKTRONIX, INC.  
P.O. BOX 500  
BEAVERTON, OR. 97005

1893270  
MP DEN INGRAM TECH STAND LAB  
MILGO ELECTRONICS CORP  
8600 NW 41ST STREET  
MIAMI FL 33156

BULK RATE  
U.S. POSTAGE  
PAID  
Tektronix, Inc.